

MWM Series

—Module Wind Turbine Controller with MPPT

User Manual

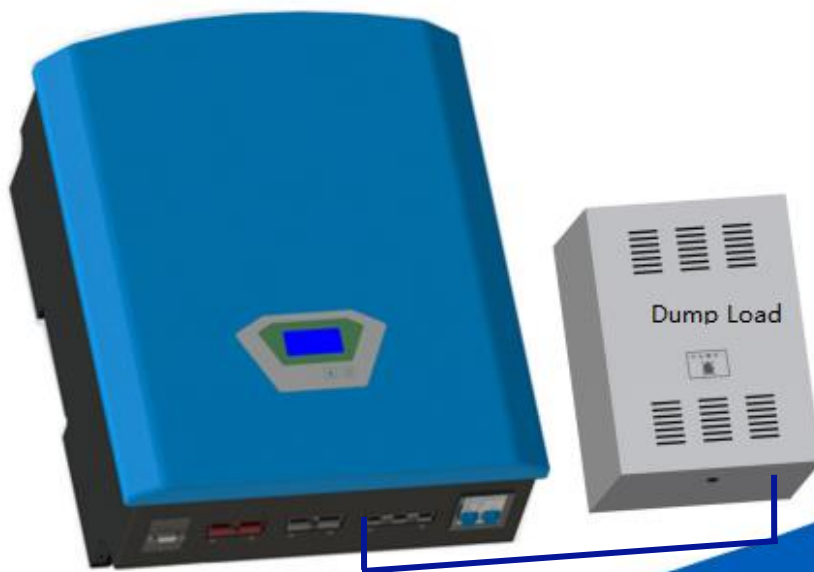

Product Model
HCM1000-48-48

Contents

1. Important Safety Warning	1
2. Basic Information	2
2.1 Introduction and Features	2
2.2 Product Structure	3
3. Product Installation	5
3.1 Installation Notes	5
3.2 Installation and Wiring.....	6
3.2.1 Installation Steps	6
3.2.2 Installation Steps	7
3.2.3 Electrical Connection.....	8
4. Operation Interface Introduction	10
4.1 LCD Display	10
4.2 LCD Information Define.....	10
5. Trouble Shooting	11
6. Technical Parameters	12
7. Warranty	13

1. Important Safety Warning

Before Using the controller, please read all instructions and cautionary markings on the unit and this manual. Store the manual where it can easily be accessed.

This manual includes all safety warnings, installation, and operation guidance of MWM wind controllers.

- Before installing and using this controller, read all instructions and cautionary markings on the controller and all appropriate sections of this guide.
- Do not use the machine in the place where has flammability and explosive gas/articles. Beware of flames and sparks.
- Please Contact our after-sales person if the machine doesn't work.
- Do not change the electrical components and parts yourself, or we will not be responsible for the warranty items and related duties.
- Please disconnect the AC input and DC output from controller before install or maintain the machine. Besides, do not touch the controller in 5 mins after disconnection.
- Please install the machine indoor to avoid the rain water enter the controller inside.
- Please keep good ventilation and heat dissipation.
- Please install a circuit breaker outside the controller if conditions are allowed.
- Please use copper cable for line connection, and choose the right diameter of cable according to the actual current.
- To avoid a risk of fire and electric shock, make sure the existing wiring is in good condition and that the wire is connected tightly.
- Do not restart the controller immediately when it alarms. Please analyze the fault reasons and repair them at first.

2. Basic Information

2.1 Introduction and Features

The MWM series wind power generation controller is the controller which integrates MPPT control and charge and discharge control. The power curve can be set by setting the wind turbine voltage and current, which can ensure the wind turbine work with the best power output all the time.

Features:

- Can be applied to grid-tied system, off-grid system and grid-tied energy storage system. Charge function is optional.
- MPPT track point settable
- Complete protection function
- Electrical components and parts in high quality.
- Several functions are optional, such as PV control function, wind speed measure function, rotational speed control function and temperature compensation function.
- RS232/RS485/RJ45/GPRS/Bluetooth/Zigbee optional. (It can be monitored by app for those with GPRS/Bluetooth/RJ45 connection)

2.2 Product Structure

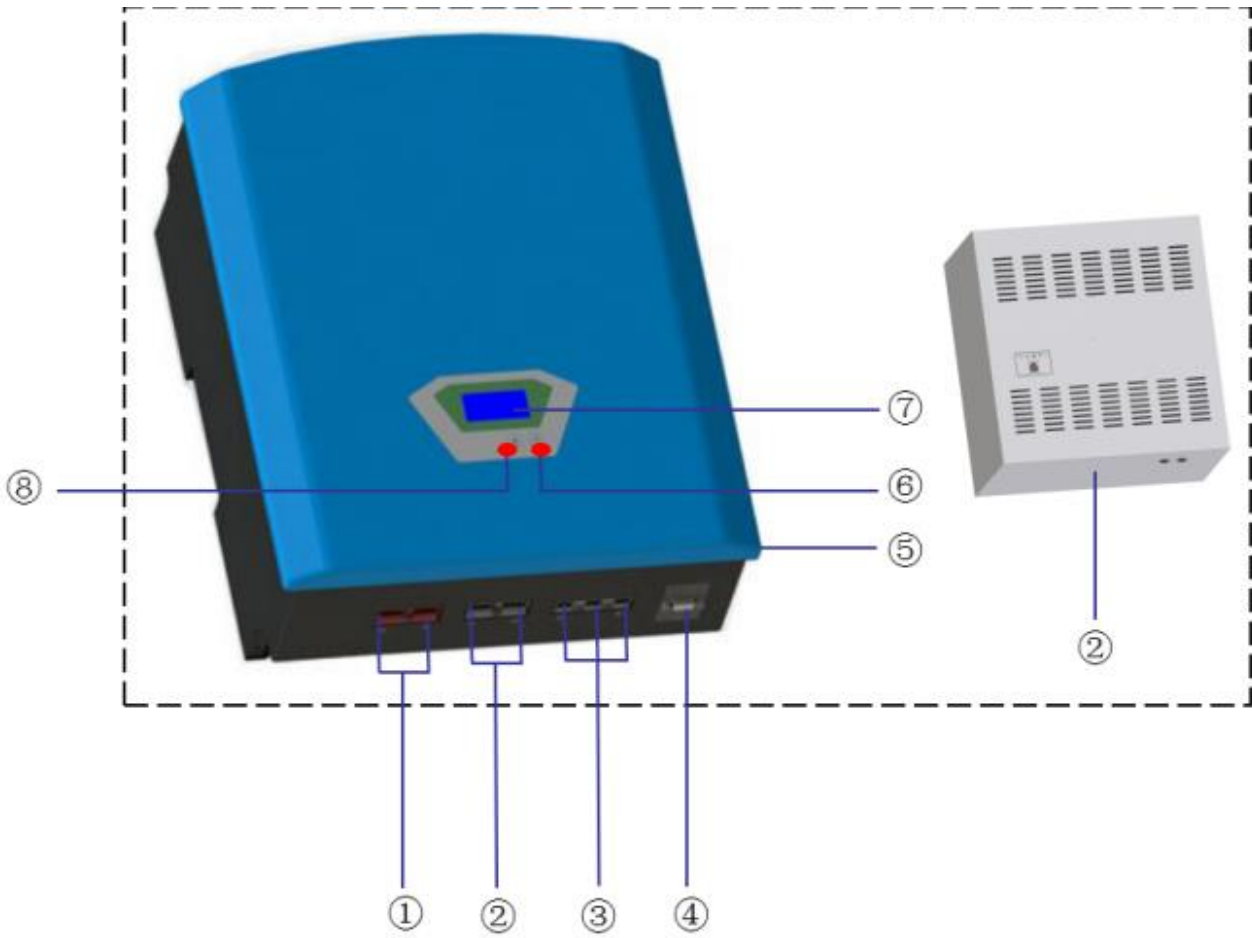

Chart1. Product Overview (1-3kW)

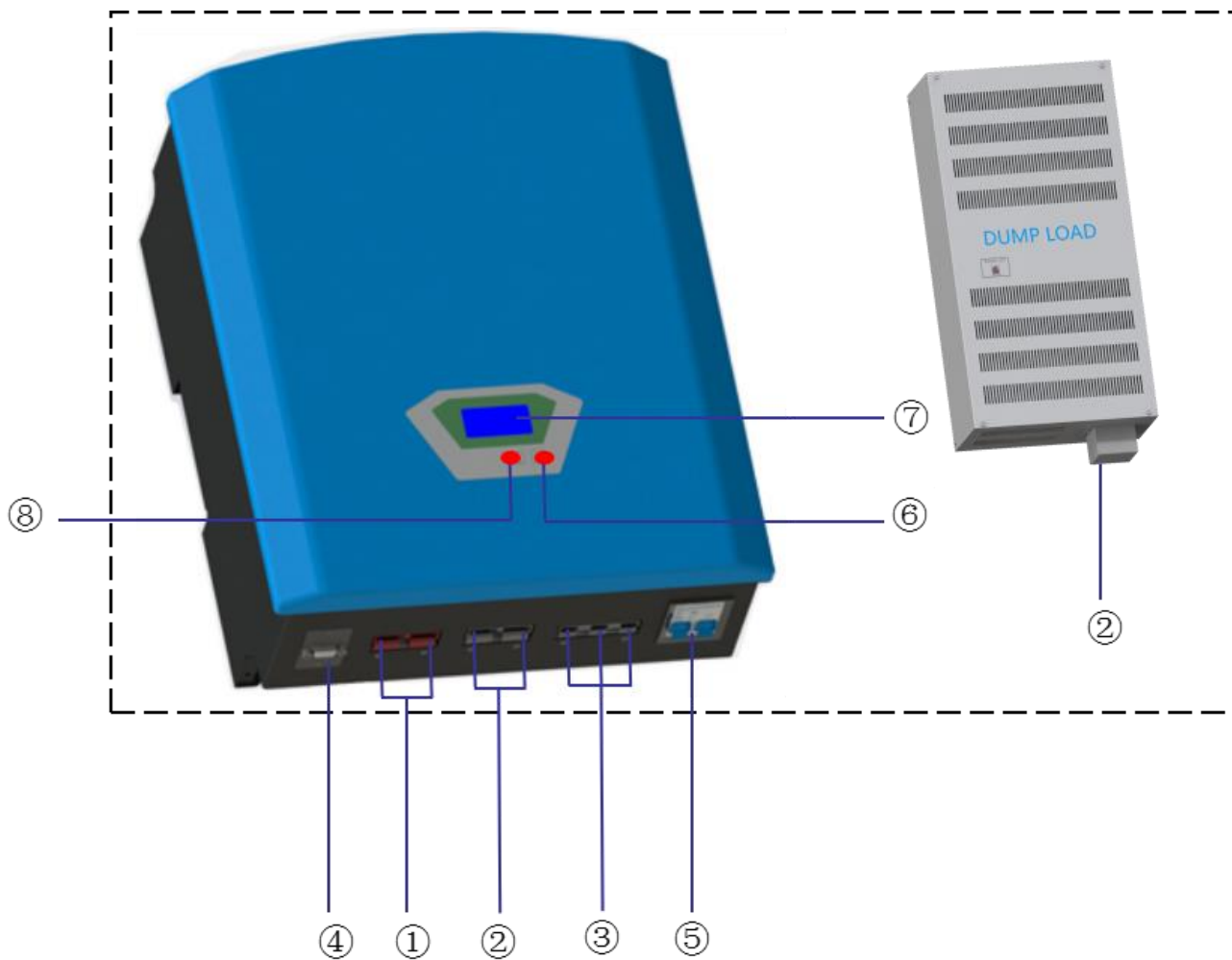

Chart2. Product Overview (5-10kW)

①	Battery terminal	⑤	Manual brake switch
②	Dump load terminal	⑥	Browse button
③	Wind turbine terminal	⑦	LCD display
④	Communication device port	⑧	Unload indicator light

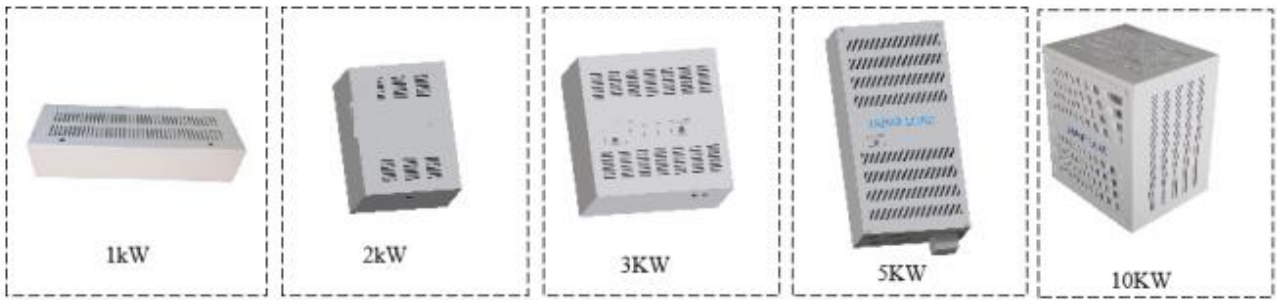

Chart3: Dump Load with different power

3. Product Installation

3.1 Installation Notes

- 1) The machine should be kept indoors and well ventilated;
- 2) Environment temperature: $-20\sim+40^{\circ}\text{C}$; Humidity: $\leq 95\%$, no condensing
- 3) Altitude should not be more than 4000m (>1000 m derating according to the GB/T3859.2 regulations).
- 4) Avoid using the machine in direct sunlight, sun exposure, rain, humidity, acid fog, and dust.
- 5) The machine can only charge for the battery in the rated voltage range.
- 6) The machine can only be connected to the wind turbine and PV with allowed power and voltage.

3.2 Installation and Wiring

3.2.1 Installation Steps

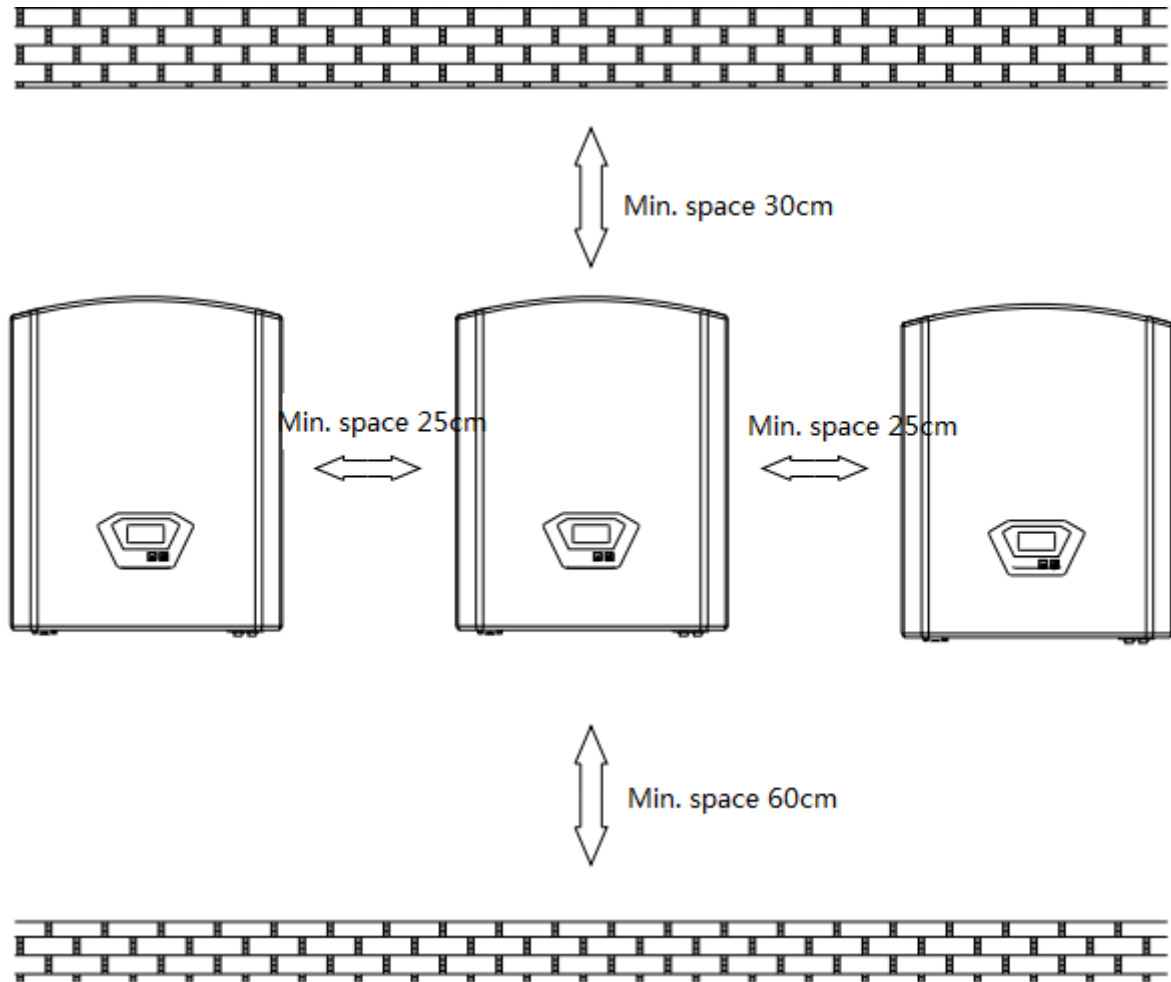

Chart 4: Installation Overview

3.2.2 Installation Steps

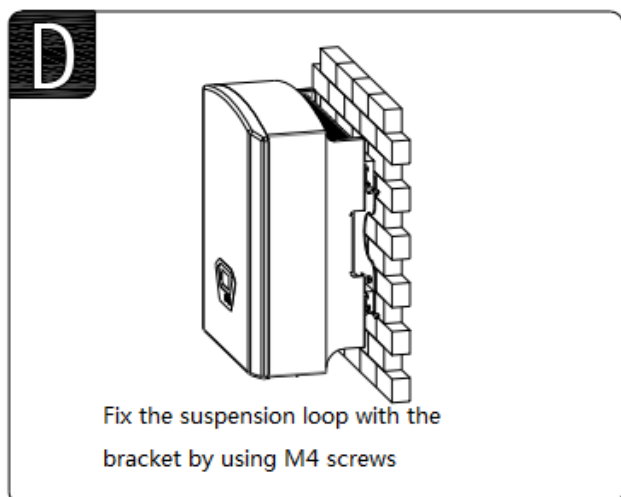
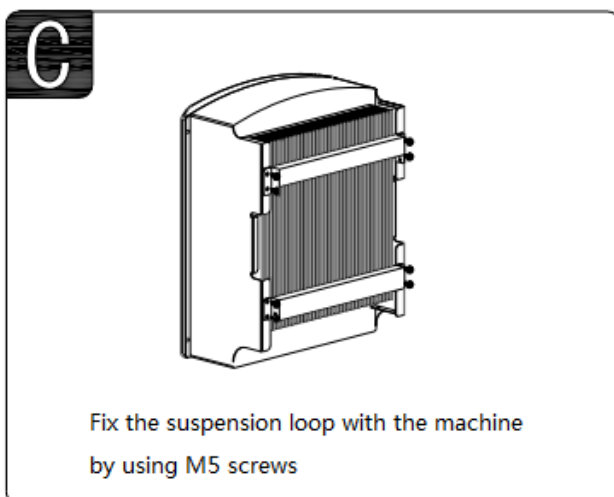
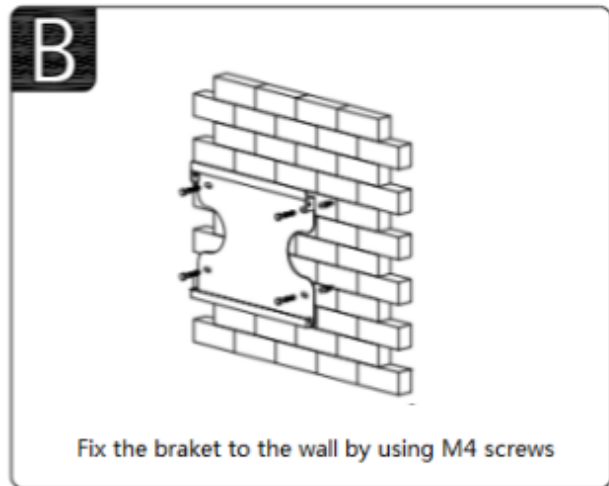
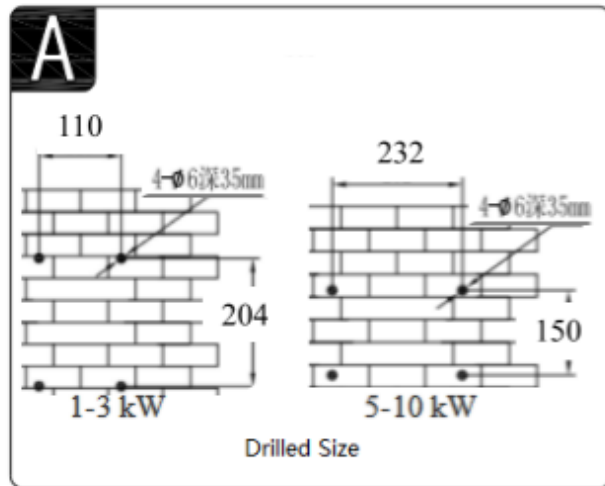
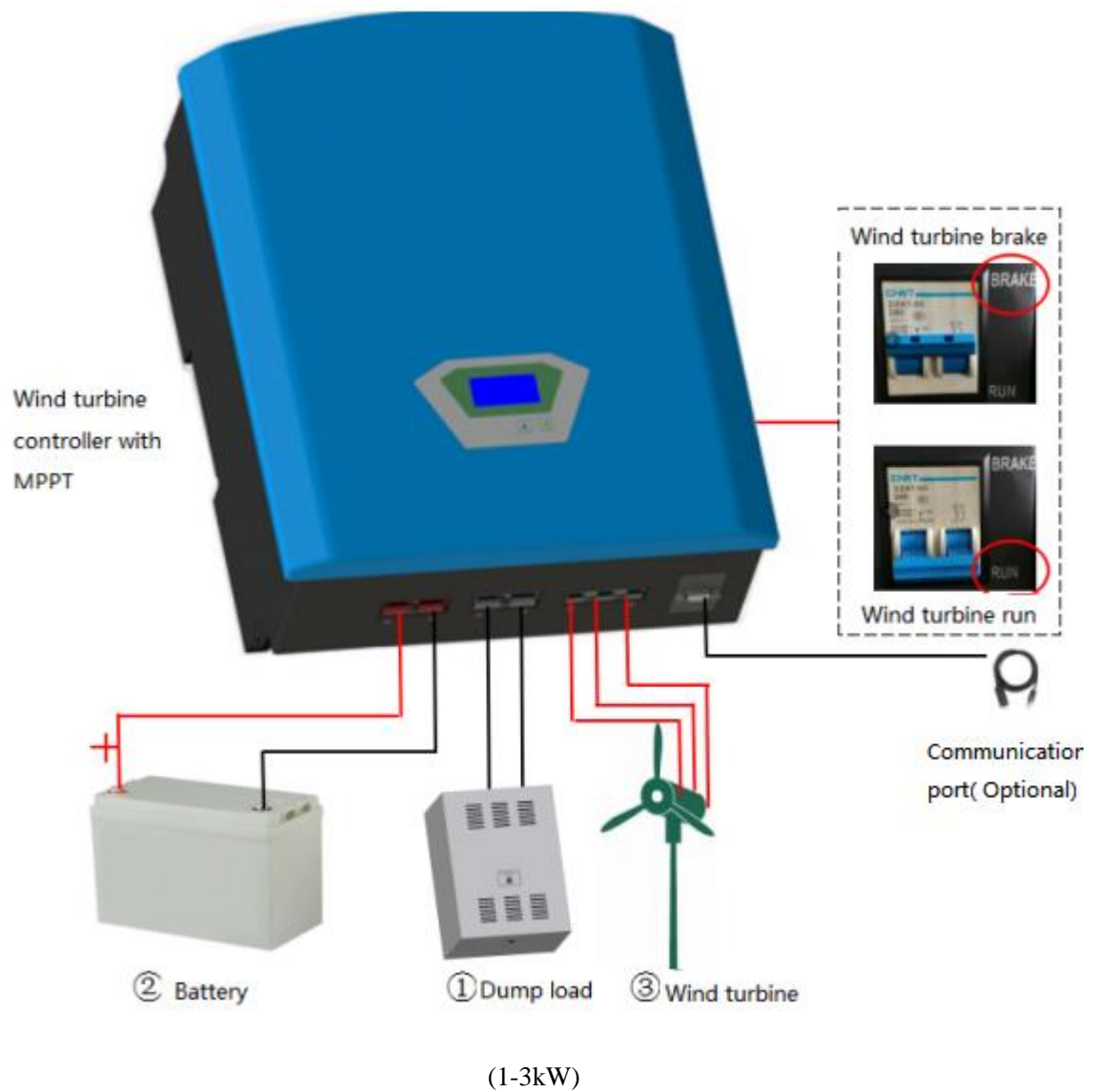

Chart5: Installation Steps

3.2.3 Electrical Connection



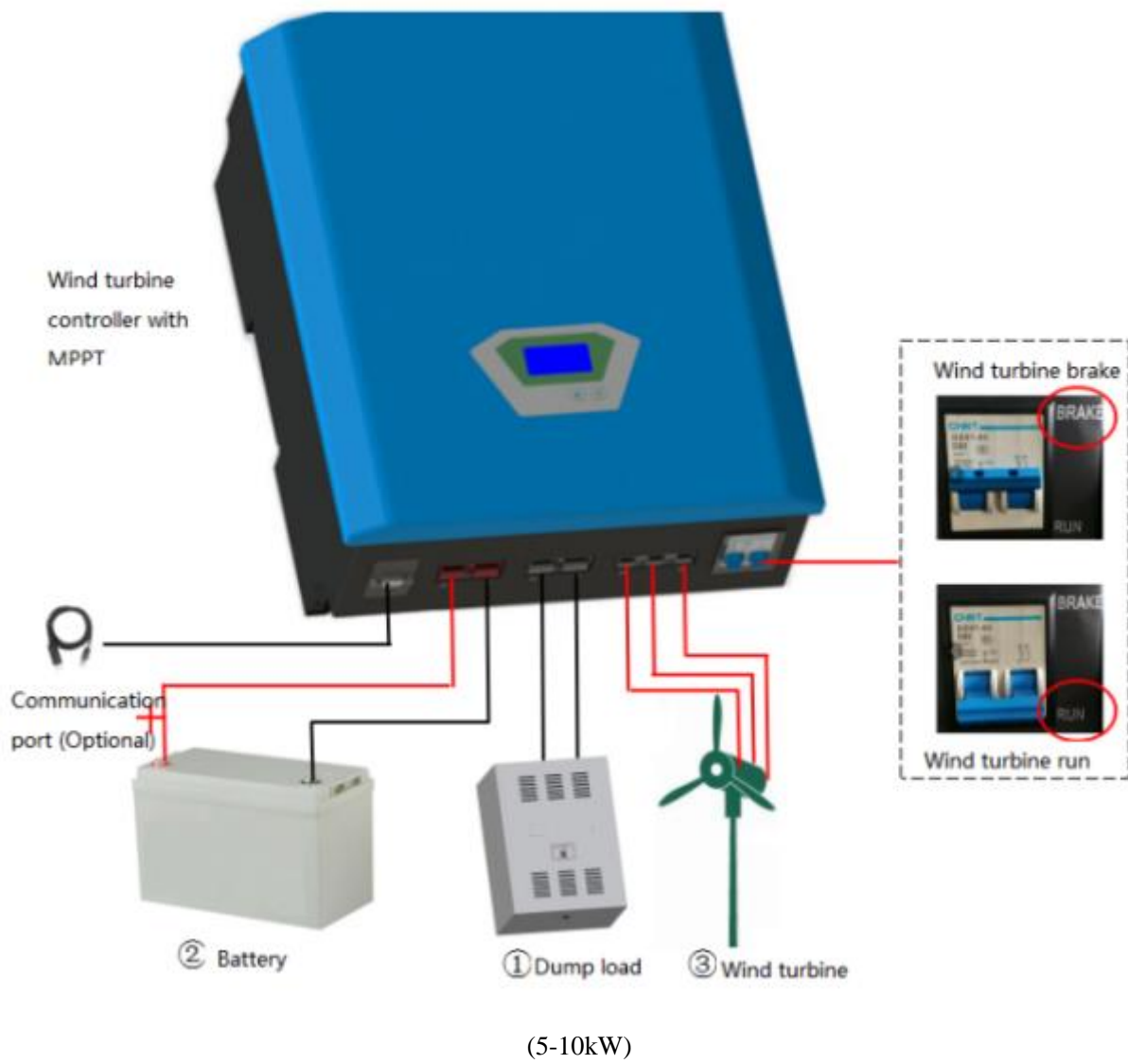

Chart 6: System Overview

Please connect those parts according to the order of ①②③, and notice the following items.

1. Connect Dump load to the controller terminal “DUMLOAD” by using copper conductor cable.
2. Connect the battery bank to the controller by the terminal which marks “BATTERY”. (do not reversed the connection of positive and negative terminals)
3. When wind turbine is still or running in a low speed, connects its output cable to the “WIND INPUT” terminal on the controller.
4. Check all the connection to make sure they are connected rightly and tightly.



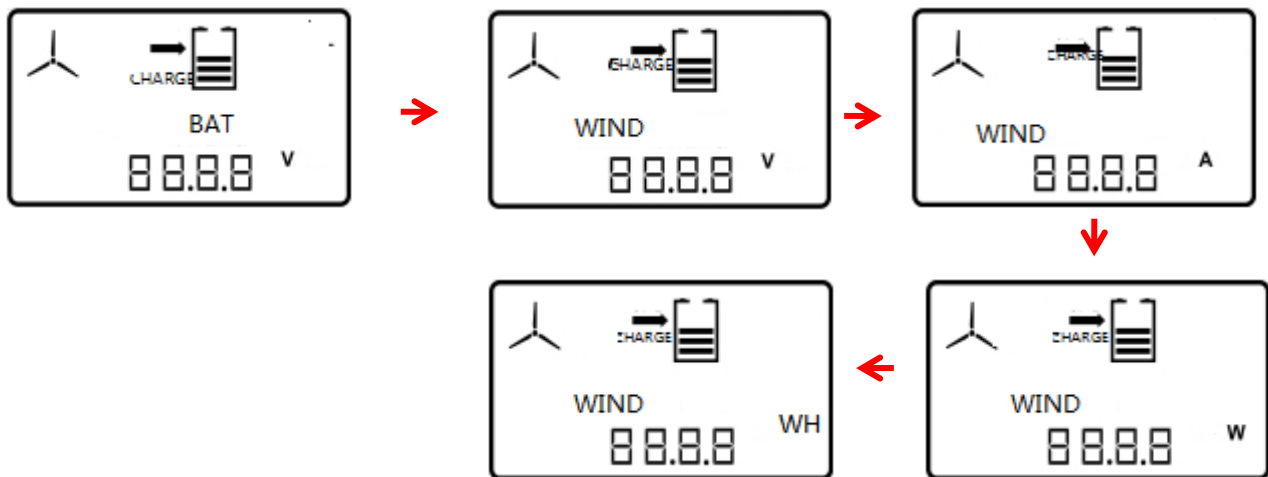

4. Operation Interface Introduction

4.1 LCD Display

After the power is connected, the whole screen is in a browsing status. It shows battery voltage, and can be changed to the following information by press related buttons.



4.2 LCD Information Define

Name	Icon	Status
Wind Turbine		Rotate means wind turbine works normally
	BRAKE	Brake by hand
Battery		Charging
		Fully charged. flickering for over voltage, stop flickering when it recover from over voltage
		Flickering means over -discharge
Browse button		Press it to enter next LCD display. Press it for 5s to enter the brake status Press it for another 5s to recover charging status.

<p>Dump load indicator light</p>		<p>Red light is on means the machine is on unload status or brake status. The light is off when it works normally.</p>
--------------------------------------	---	--

5. Trouble Shooting

Fault Type	Description	Possible reasons and solutions
No display on LCD	The connection between the battery and the controller is not tight	Check the wiring, and reconnect it.
	DC breaker is not on between battery and controller	Turn on the breaker
	Low battery voltage	The system parameters are not matched correctly. Recheck the label and parameters on the machine.
		The battery doesn't work. Change a new one.
Battery is connected in wrong polarity to battery input terminals.	Need change the internal fuse in controller, and reconnect the battery.	
No charging	The connection cable between wind turbine and controller is loose.	Reconnect and fix the cables.
	Wind turbine output voltage hasn't reached the charging voltage,	Check whether the system voltage is reasonable.
	Wind turbine is in "Brake" status	<p>Wait the wind turbine recover if it brakes automatically. Press the button for 5s to release the brake status if it brakes by hand.</p>
	Battery is already fully charged.	Check if the battery voltage has reached its output overvoltage.

6. Technical Parameters

Model	HCM1000-48-48
Type	Boost
Wind Turbine Input	
Rated input power	1kW
Rated input voltage	48V
Input voltage range	0~64V
Start charge voltage	12Vdc (factory default, 8Vdc~64Vdc settable)
Rated input current	21Adc
Brake by hand	Keep press the button for 5s to unload completely, and then recover by hand. Switch “ON” the brake switch
Brake by over current	21A (factory default, 0~25A settable)unload completely when reached the set current, and recover automatically after working 10mins.
Brake by overvoltage	Refer to “output overvoltage” control
Charge Parameters	
Rated battery voltage	48Vdc
Start unload voltage	56Vdc (factory default, 44Vdc~64Vdc settable)
Complete unload voltage	58Vdc (factory default, add 2V to the start unload voltage)
Max. Output current	21Adc
General Parameters	
Rectifier mode	Uncontrolled rectifier
Display mode	LCD
Display information	DC output voltage, wind turbine voltage/current/power. For those with charge control function, Battery voltage is showed as well.
Monitoring mode	RS232
Monitoring Contents	Real-time display: DC output voltage, wind turbine voltage/current/power.

	For those with charge control function, Battery voltage is showed as well.
	Parameter setting: Output overvoltage point, wind turbine over current point, wind turbine start voltage, and wind turbine brake settings.
Lightning protection	YES
Conversion efficiency	≥92%
Static loss	<2W
Ambient temperature	-20°C~+40°C
Humidity	0~90%, No condensing
Noise	≤65dB
Cooling mode	Forced air cooling
Installation mode	Wall-mounted
Cover protection class	IP42
Product dimension (W*H*D)	300×375×145mm
Product net weight	10kg
Dump load dimension (W*H*D)	360*80*120mm
Dump load net weight	2.8kg
Note: Part of parameters can be adjusted according to customer's specific demand.	

7. Warranty

The product shall be in warranty for one year from production. Please take contract as the final one if it has special terms on warranty.